

FABLAB KAMP-LINTFORT, RHINE-WAAL UNIVERSITY OF APPLIED SCIENCES

HSRW VISOR

V1.0 (LASER CUT)

[HTTPS://FABLAB.HOCHSCHULE-RHEIN-WAAL.DE/VISIER](https://fablab.hochschule-rhein-waal.de/visier)



INTRODUCTION

HSRW Visor consists of a flexible headband and extended face shield which covers both the sides and the top of the wearer's face. The visor is specially designed to be comfortable during prolonged wearing. The HSRW Visor has been tested and proved to be useful by the [St. Bernhard-Hospital Kamp-Lintfort](#).

FIND THE FILES HERE

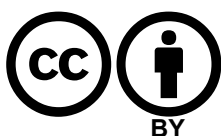

CONTENTS

MATERIALS AND EQUIPMENT	4
LASER CUTTER	4
MATERIALS	4
PETG FOIL	5
POM-C	5
PRODUCTION	6
FILE PREPARATION	6
LASER SETTINGS AND PRODUCTION	8
ASSEMBLY	10
ATTACHMENT OF THE HEADBAND	11
ATTACHMENT OF THE SHIELD	12
ATTACHMENT OF THE BOTTOM FRAME	13
ELASTIC BAND AND WEARING	13
CREDITS	14

THE HSRW VISOR

The laser cut version, has been designed to be produced using laser cutting technology. Laser cutting ensures quick production time, making it possible to produce and assemble one complete shield in about 15 minutes.

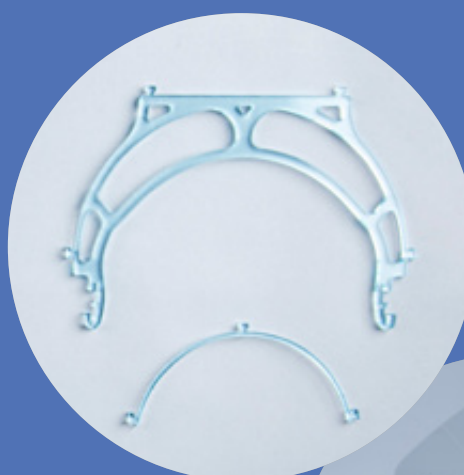







MATERIALS & EQUIPMENT









LASER CUTTER

For its manufacture, the HSRW Visor requires a laser cutting machine. To be able to successfully cut the materials, the laser cutter must satisfy the following requirements:

Check List

-   **CO2 LASER SOURCE**
-   **MINIMUM POWER OF 60W**
-   **MINIMUM CUTTING AREA OF 450X400MM**



The following additional laser cutter specifications are recommended to ensure cleaner cutting and to enable more efficient processing of multiple parts at once:

-   **AIR ASSIST**
-   **PULSED CO2 LASER AND/OR FREQUENCY/PPI SETTINGS**
-   **LASER POWER COMPENSATION**
-   **WIDE CUTTING AREA, (EG 1000X600MM)**

.....

MATERIALS

The base materials required to produce the shield are the following:

-  **PETG FOIL TRANSPARENT CLEAR, THICKNESS OF 0.5MM**
-  **POM-C PLATE, 6MM THICKNESS**
-  **ELASTIC BAND**

PETG FOIL

Make sure the PETG you purchase is transparent and clear, and that it is specifically meant to be used for looking through. Some producers are selling transparent or clear PETG, but the material may have some superficial blurriness, which can make focusing through the mask rather difficult. Look for material which the manufacturer has declared to have excellent transparency or which is intended for use in product displays. PETG has been selected because it cuts cleanly and precisely in a laser cutter, and because it can also be processed with industrial vacuum forming technologies, opening possibilities to scale up production into an industrial setting. The following two figures show examples of the PETG used for the production of the shield prototypes - note when they are delivered, the PETG sheets will be covered in a protective foil to ensure they don't get scratched during transport and handling. The first figure shows the flexibility of a PETG sheet with protective foil.



The following figure shows the transparency of the PETG, in a small corner where the protective foil has been removed.



Further material specifications can be found by following this link: [PETG properties](#)

POM-C

Proved to be disinfectable and robust by the [St. Bernhard-Hospital Kamp-Lintfort](#), POM-C is an engineered plastic with excellent mechanical strength and wear characteristics. POM-C can be processed by both laser cutting and CNC milling technologies. The figure below shows an example of the POM used for the production of the shield prototypes:

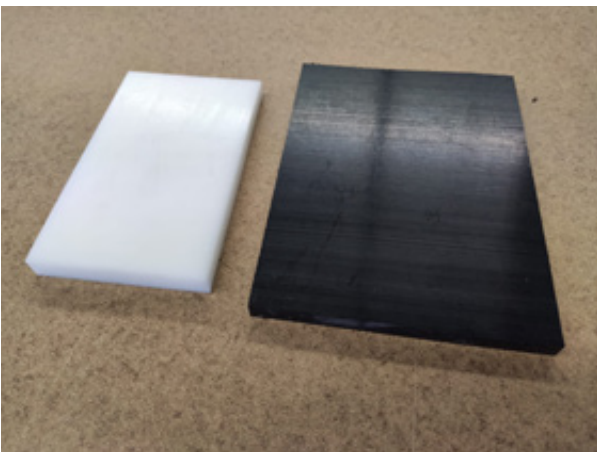

Further material specifications can be found by following this link: [POM-Acetal properties](#)

PRODUCTION

The latest version of the design and latest updates can be found here:
<https://fablab.hochschule-rhein-waal.de/visier>

FILE PREPARATION

Files are provided in the following formats:

F3D (Fusion 360)
SVG
STL
PNG

For use on the laser cutter both DXF and SVG files are recommended, because they are vector file formats and hence represent the design cut lines most precisely. To save time and material, it is convenient to produce multiple parts in one laser cut job, by grouping them by the type of material. It is also recommended to position the objects as close as possible to each other, and/or to nest them before cutting, to speed up the manufacture and to minimise wear and tear on the machine. In total, there are four parts that need to be produced for each mask. The parts and their dimensions are as follows:



POM 6MM

Shield frame, 208x142mm
Shield bottom, 140x60mm



PETG 0.5MM

Frame headband, 250x24mm
Shield cover, 360x397mm

Below is an example of how the frame and bottom can be nested when cutting 6mm POM:

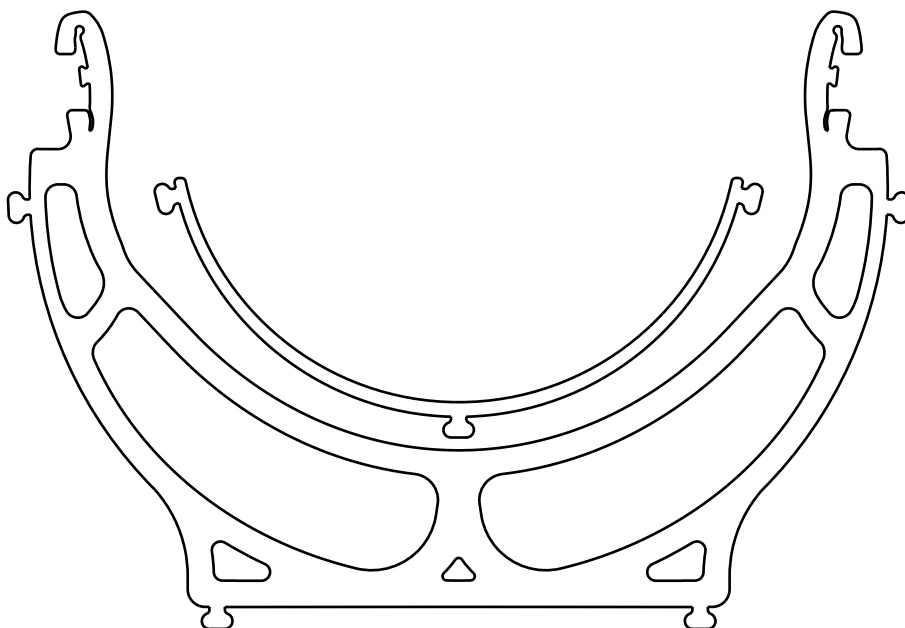

Below is an example of a layout for cutting the shield and headband from 0.5mm PETG:

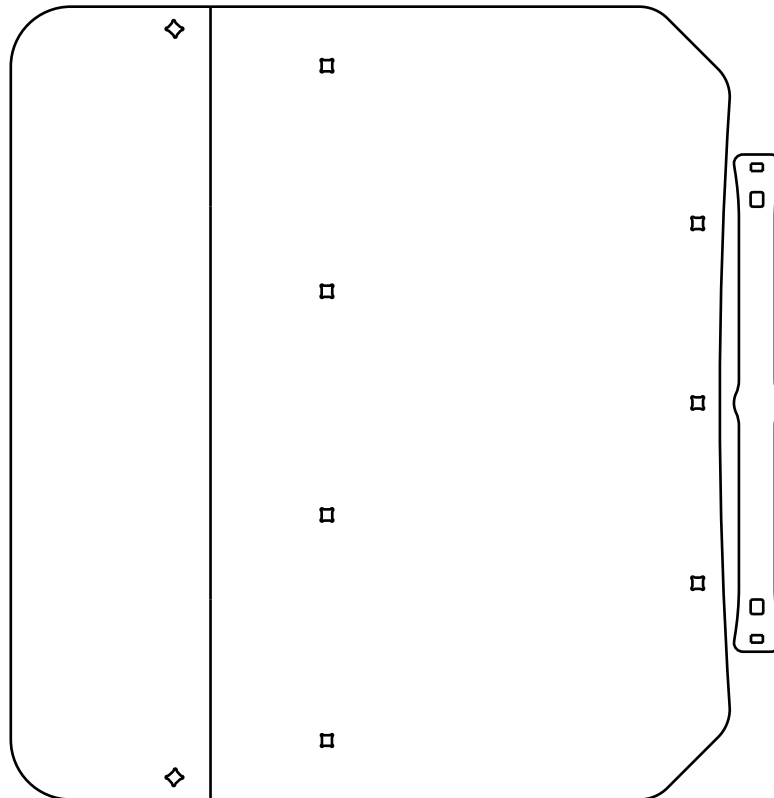

If a large format laser cutter is available (eg 1000x600mm or larger), then it is possible to cut multiple parts of the same type at once, to further save material, costs, time and wear on the machine. Below is an example of multiple copies of the frame and bottom nested together:

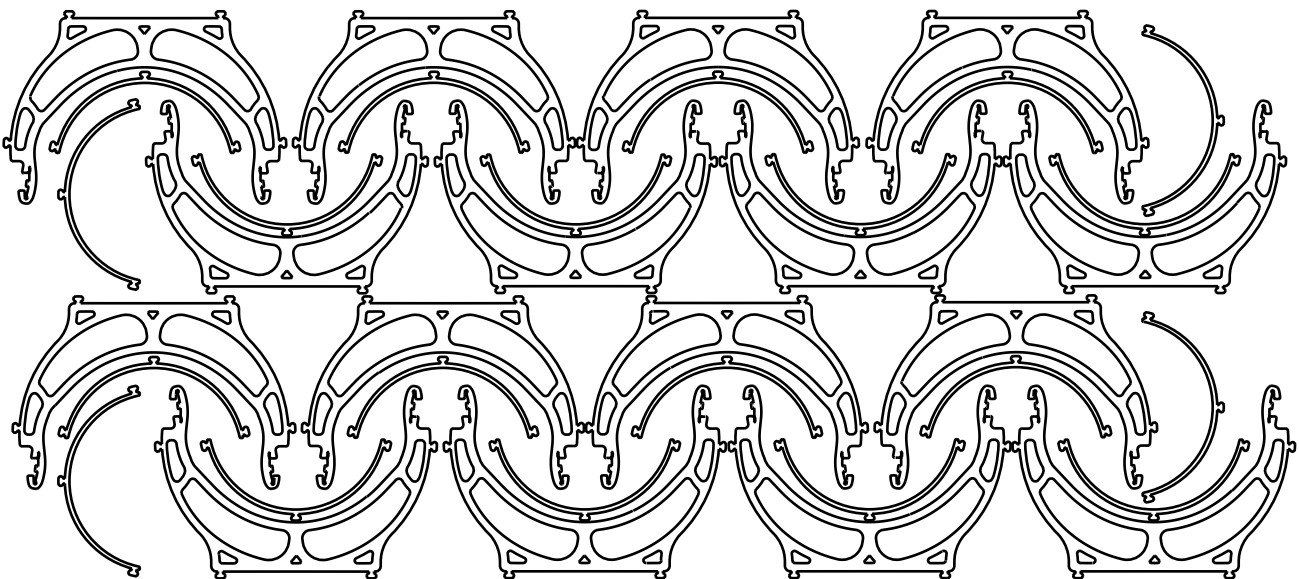

Finally, an example of multiple copies of the shield and headband parts packed together:

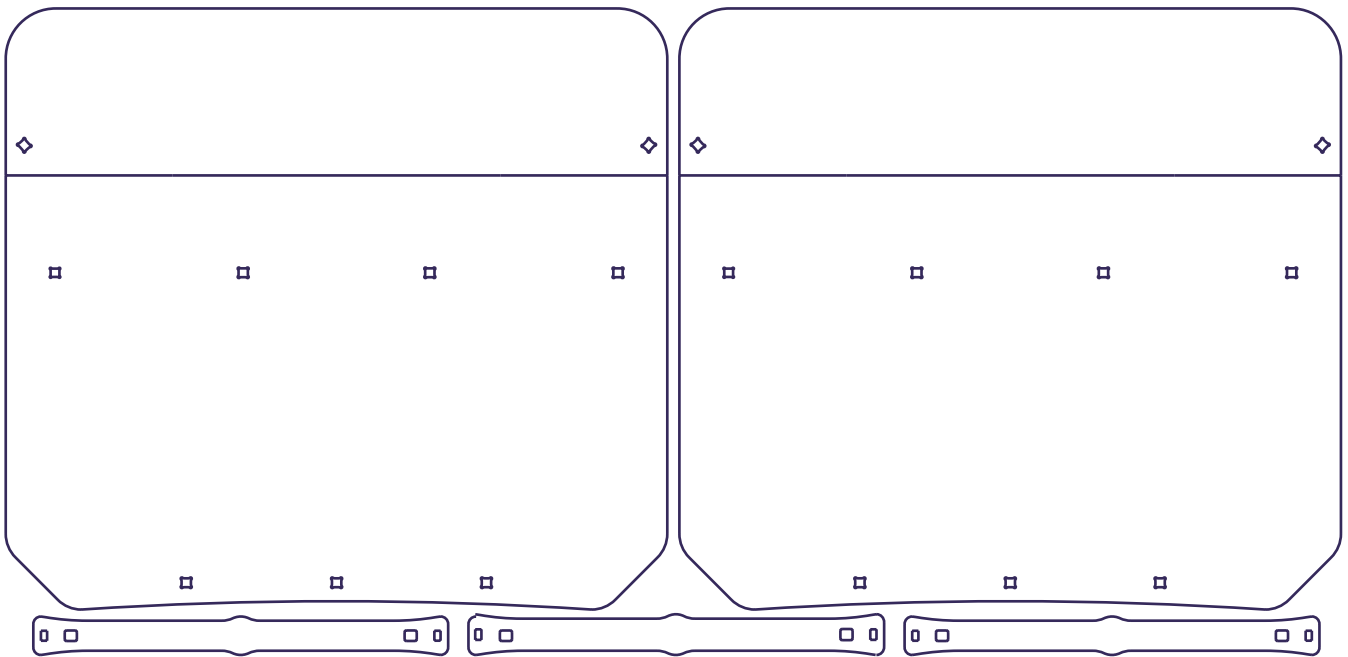

LASER SETTINGS AND PRODUCTION

As a reference for setting up your own machine, here are settings we have used for our laser cutter machines.

EPILOG FUSION M60 60W CO2 LASER SETTINGS	LASER SETTINGS FOR LASER CUTTERS WORKING IN MM/S
---	---

cutting settings for the shield frame and shield bottom

POM 6MM

Power: 100%
Frequency 100%
Speed: 2%
Power compensation: activated

Power: 100%
Speed: 4mm/s

engraving settings for the shield bending line

PETG 0.5MM

Power: 100%
Frequency: 100%
Speed: 65%
Power compensation: activated

Power: 100%
Speed: 40mm/s

engraving settings for the shield bending line

PETG 0.5MM

Power: 100%
Frequency: 100%
Speed: 65%
Power compensation: activated

Power: 100%
Speed: 25mm/s

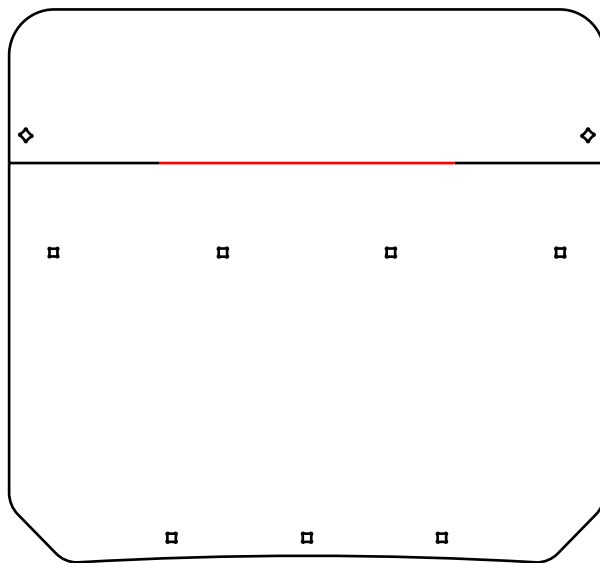

We recommend that you do a cutting test with a small piece (eg 10mm circle) if you have never cut these particular materials before on your laser cutter, to avoid having problems when you start cutting the larger parts.



Note carefully the red section of the central line through the shield. The plastic will be bent along this part of the line, so it has to be engraved and not cut through. The requirement is to engrave it to about half thickness of the material. It is recommended to first engrave this line, and then cut out the rest of the design (the black lines), to avoid unwanted shifts and consequent inaccuracies.

When placing the materials inside the laser cutter, ensure they are completely flat. This is to avoid different focus lengths, which can result in incomplete cuts. If the PETG sheet you are using has some bent areas or sides, it is possible to fix the problem using masking tape. Below is an example of bent corners and the right method to correct the problem with tape. If, despite all of these preparations, you do end up with some incomplete cuts, we recommend that you do not move the material and to launch the same job again so that the laser cutter can finish the job properly on the second pass.



ATTENTION: avoid bent areas



ATTENTION: fix the problem using masking tape

ASSEMBLY

Remove the protective foils, if present, from all of the materials before assembling the visor. The following parts have to be assembled in order to have a functional HSRW Visor:

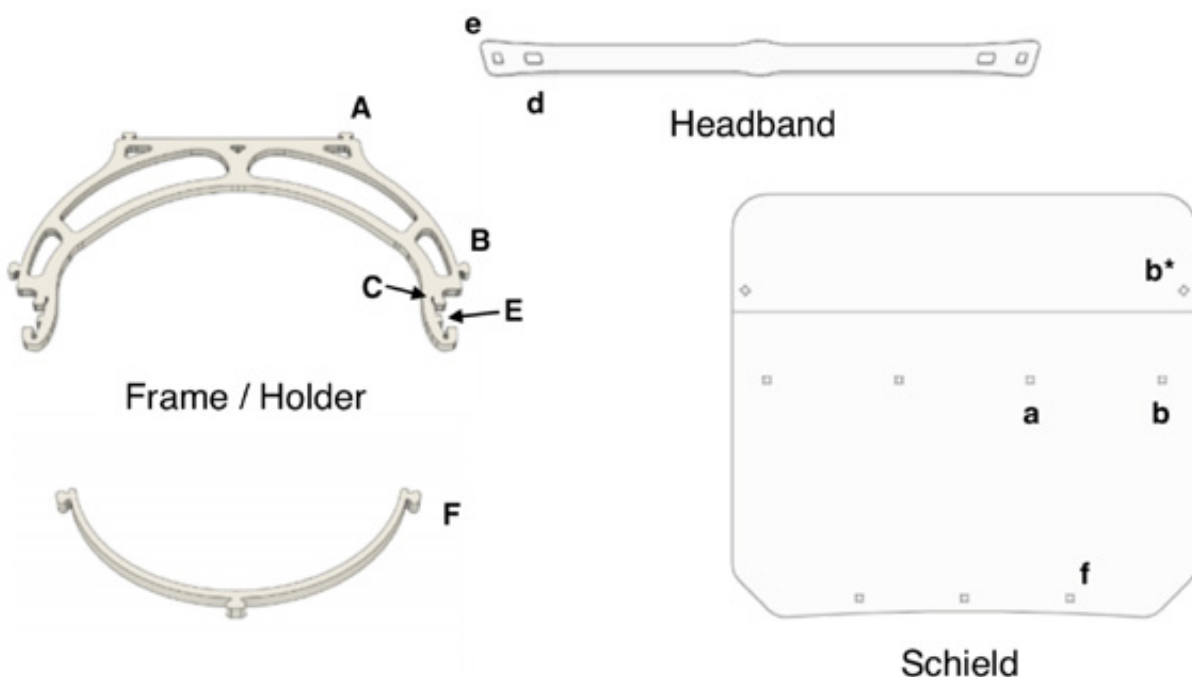

ATTACHMENT OF THE HEADBAND

The first step is to attach the headband to the frame. This operation requires you to fix the headband on one side before attaching it to the other side. The end of the frame needs to pass through bigger hole in the headband (d) as shown below:



After fixing one end of the headband, attach the other end in the same manner:



To fix the headband on the side, slip the long slot (d) forward along the frame into the slit (C), then slip the end of the headband into the other slit and firmly push the rectangular hole (d) over the square knob (E). The final fixing of one side is shown below:



The following picture shows the headband fully assembled and fixed into position:



ATTACHMENT OF THE SHIELD



The next step is to attach the shield to the frame. First gently bend the shield along the engraved line, up to a few degrees. Ideally the PETG shield will open up a bit and hold a slightly bent shape. The side into which the bending line (the red line highlighted earlier) was engraved is identified as the outside of the shield. To attach the shield proceed first by pushing the holes (a) over the outer-front knobs of the frame (A), one at a time. This is most easily done by inserting the shield at an angle and then pushing it to the other side, as shown below:

The shield attached to the front knobs:



The shield with all the frame knobs attached:



Once the shield is attached to the front knobs, it is ready to be attached to the knobs on the side. The shield can be bent as necessary by hand to ease the holes (b) over the knobs (B):

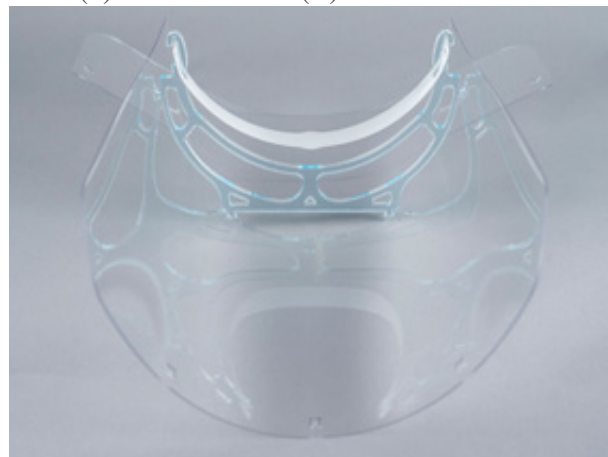

To complete the attachment of the shield, slip the upper 2 holes (b*) over the side knobs (B) of the frame. Bend the upper part up so that the hole reaches the knob and push it through:



ATTACHMENT OF THE BOTTOM FRAME

The next step is to attach the bottom part. The bottom is necessary to give the lower part of the shield the proper diameter, to avoid accidental contacts of the shield with the face of the wearer. The attachment involves pushing the holes (f) over the knobs (F) of the bottom frame.



Once both top holes are fixed with the side knobs, the shield is completely attached to the frame:



ELASTIC BAND AND FITTING

The final step is to fix the elastic band to the frame edges and to test the fit of the shield on yourself:

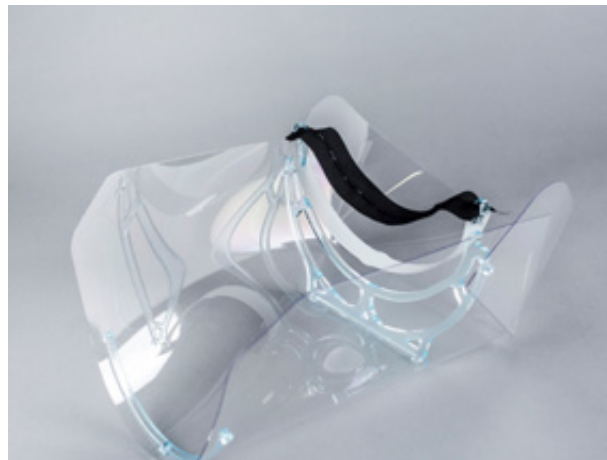



CREDITS

We would like to take this opportunity to say thank you to all who have helped so intensely during this extraordinary time and in particular to those who have contributed to the development of the design presented here. Special thanks go to two FabLab Kamp-Lintfort employees who developed the design: Ahmed Abdellatif and Daniele Ingrassia. Thanks is due also to everyone else on the FabTeam, because without you this action would not have been possible.

Finally, we would like to express our thanks to all those involved in the supporting organizations in the Wesel and Kleve districts and to all those who are so actively involved in the background.

Layout by Adriana Cabrera
Translation by Susanne and William Megill
Photos by Christian Spieß, TROK-MEDIA

WARNING

This is a non-certified medical device. Please note that production and use is at your own risk.

HOCHSCHULE RHEIN-WAAL

Friedrich-Heinrich-Allee 25
Fakultät Kommunikation und Umwelt
47475 Kamp-Lintfort

Kontakt
Prof. Dr. Karsten Nebe
FabLab Direktor
Telefon: +49 2842 908 25 – 233

Dr. Martin Kreymann
FabLab Manager
Telefon: +49 2842 908 25 – 271

fablab.hochschule-rhein-waal.de

E-Mail: fablab@hochschule-rhein-waal.de
<https://www.facebook.com/fablabkamplintfort/>